

SLV SPANNINGSRAIL SYSTEMEN

3-fase stroomrailsystemen voor professionele lichtprojecten



altijd up-to-date!

download de actuele prijslijst op

KS-Licht.nl/prijslijst_3-FASE

of scan de qr-code hieronder!



Vind [hier](#) onze voorwaarden voor zakelijke klanten



KS LICHT en SLV: al meer dan 30 jaar sterke partners in verlichting

OPHAALCENTRUM IN ESSEN

Al meer dan 30 jaar vult KS Licht- und Elektrotechnik GmbH de producten en diensten van SLV aan met diverse diensten. Wij beschikken over een afhaalcentrum voor SLV-producten in het hart van het Ruhrgebied, waar u de bij ons bestelde goederen op korte termijn kunt afhalen.

ERVAAR SLV VERLICHTING LIVE

Op meer dan 300 m² expositieruimte presenteren wij een ruime keuze aan SLV-armaturen. Onze professionele adviseurs en verlichtingsspecialisten geven u graag persoonlijk advies. Tegelijkertijd kunt u van onze tentoonstelling gebruik maken om onze armaturen qua functie en effect aan uw klanten voor te stellen. Overtuig uzelf van de kwaliteit van onze buitenarmaturen op de openlucht tentoonstelling.

GRATIS LICHTONTWERP

Wij ontwikkelen samen met u en op basis van uw behoeften praktische verlichtingsoplossingen. Of het nu gaat om bedrijfsruimten, verkoopruimten of privé-omgevingen: onze lichtontwerpers hebben altijd de juiste concepten voor een behoeftegerichte en energiebesparende oplossing. Wij berekenen graag voor u de terugverdientijd van uw nieuwe energiezuinige LED-verlichting.

KS MULTIBRAND VERLICHTING ONLINE SHOP

In onze professionele online winkel op www.KS-Licht.nl vindt u alles wat u helpt in je dagelijkse werk:

- Huidige speciale aanbiedingen en nieuwe producten
- Online controle van de beschikbaarheid van producten
- Gemakkelijk alle reserveonderdelen vinden en bestellen
- Snel bestelformulier
- Alle catalogi als downloads of als bladerbare catalogi met links naar de producten
- Specificatieteksten, lichtverdelingscurven /LDT plug-ins en Snelle berekeningstabellen

KS Licht- u. Elektrotechnik GmbH
Manderscheidtstr. 8c
45141 Essen

Tel.: +49 (0)201-89924 - 0
Fax: +49 (0)201-89924 - 124

Onlineshop: www.KS-Licht.nl
Internet: www.KS-Germany.com
Email: Verkauf@KS-Germany.com

Bezoek ons ter plaatse of bel ons:
Maandag tot donderdag van 08:00 tot 16:30
Vrijdag van 08:00 tot 15:00

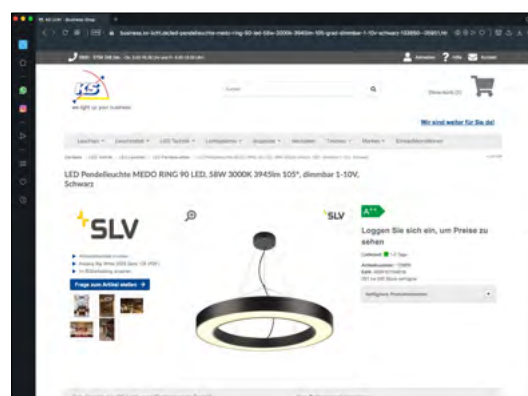

Scan de link naar ons snelle bestelformulier en krijg actuele informatie over de beschikbaarheid van goederen!



www.ks-licht.nl/snel-bestelformulier



Ook in situaties waarin het technisch complex wordt: het SLV spanningsrail systeem kent zoveel elementen, die eenvoudig gecombineerd kunnen worden, dat er voor elk project een goede oplossing te maken is.

INHOUD

SLV S-TRACK SYSTEEM

3-fase opbouwrail en toebehoren **6–9**

3-FASE ARMATUREN

NUMINOS® S, M, L **10–15**

NUMINOS® S, M, L DALI **16–21**

SIGHT MOVE DALI **22–23**

SIGHT TRACK DALI **24–25**

ONE 40 TRACK DALI **26–27**

EUTRAC® SYSTEEM

3-fase opbouwrail en toebehoren **28–31**

EUTRAC® SYSTEEM

3-fase-inbouwrail en toebehoren **32–33**

COMPATIBILITEIT

3-fase spanningsrail **34–35**

NUMINOS® CONFIGURATOR

Spots online configureren **36–37**

Symboolverklaring

39



S-TRACK

3-fase-opbouwrail DALI

Uw professionele rails.

De 3-fase S-TRACK spanningsrails zijn ideaal voor winkels, musea, hotels en restaurants of zelfs grotere woningen. Dankzij het grote aantal krachtige spots kunnen verschillende lichtscenario's worden gerealiseerd en met gescheiden stroomcircuits afzonderlijk worden geschakeld.

- Grote keuze aan krachtige spots
- Afzonderlijk schakelbare circuits
- Relatief onafhankelijk van stroompunten
- Schaalbaar dankzij talrijke railelementen
- DALI-compatibel voor slimme verlichtingsprojecten

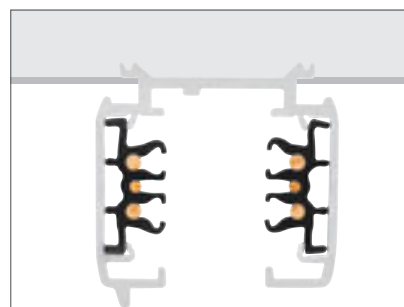

	1 m	1 m	2 m	2 m
Nominale spanning (V)	220-240V ~50/60Hz	220-240V ~50/60Hz	220-240V ~50/60Hz	220-240V ~50/60Hz
Max. stroomsterkte (A)	16	16	16	16
Mech. belasting max.	30 kg	30 kg	30 kg	30 kg
Materiaal	Aluminium	Aluminium	Aluminium	Aluminium
Kleur	■ zwart	□ wit	■ zwart	□ wit
L x B x H (cm)	100 x 3,6 x 3,6	100 x 3,6 x 3,6	200 x 3,6 x 3,6	200 x 3,6 x 3,6
Gewicht (kg)	0,9	0,9	1,84	1,84
Art. nr.	1004937	1004938	1002631	1002632



	3 m	3 m	4 m	4 m
Nominale spanning (V)	220-240V ~50/60Hz	220-240V ~50/60Hz	220-240V ~50/60Hz	220-240V ~50/60Hz
Max. stroomsterkte (A)	16	16	16	16
Mech. belasting max.	30 kg	30 kg	30 kg	30 kg
Materiaal	Aluminium	Aluminium	Aluminium	Aluminium
Kleur	■ zwart	□ wit	■ zwart	□ wit
L x B x H (cm)	300 x 3,6 x 3,6	300 x 3,6 x 3,6	400 x 3,6 x 3,6	400 x 3,6 x 3,6
Gewicht (kg)	2,76	2,76	3,53	3,53
Art. nr.	1002633	1002634	1002635	1002636

S-TRACK

3-fase-opbouwrail DALI

Planningshulp en toebehoren in één overzicht

Zicht op de componenten van
bovenaf op de montagezijde

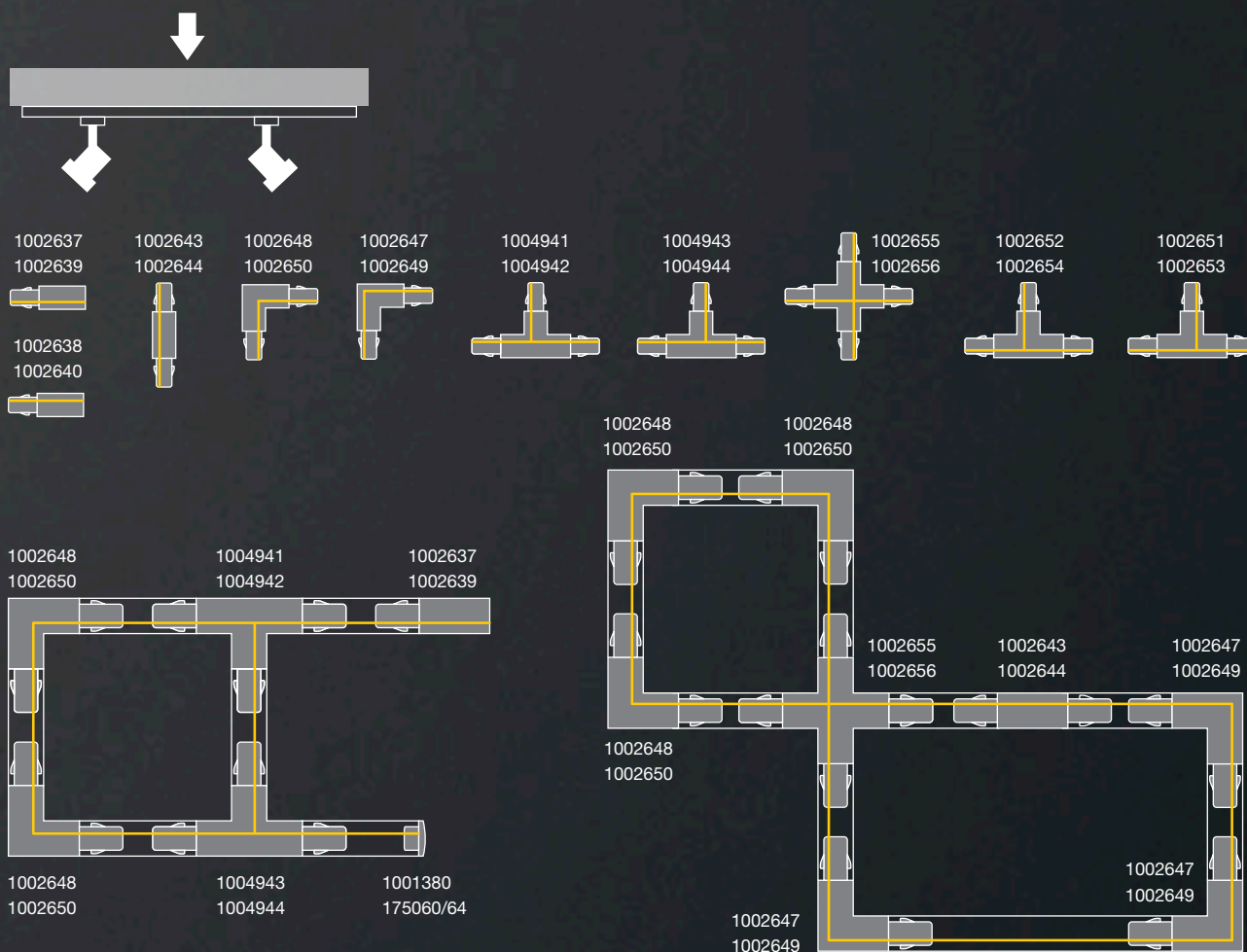

	<p>Voeding, DALI, aarde links 10A max. polycarbonaat (PC) L: 13,9 cm B: 3,5 cm H: 3,3 cm</p> <p>■ zwart Art. nr. 1002637 □ wit Art. nr. 1002639</p>		<p>Isolatieverbinder Polycarbonaat (PC) L: 6,8 cm B: 3,1 cm H: 2,6 cm</p> <p>■ zwart Art. nr. 175080 □ wit Art. nr. 1001382</p>
	<p>Voeding, DALI, aarde rechts 16A max. Polycarbonaat (PC) L: 13,9 cm B: 3,5 cm H: 3,3 cm</p> <p>■ zwart Art. nr. 1002638 □ wit Art. nr. 1002640</p>		<p>Bevestigingsklem Staal L: 4 cm B: 3,4 cm H: 1,25 cm</p> <p>■ zwart Art. nr. 1002657 □ wit Art. nr. 1002658</p>
	<p>Voeding, DALI, aarde buiten 16A max. Polycarbonaat (PC) L: 11,9 cm B: 11,9 cm H: 3,3 cm</p> <p>■ zwart Art. nr. 1002647 □ wit Art. nr. 1002649</p>		<p>3-fase-adapter, DALI 10A max. polycarbonaat (PC) L: 11,3 cm B: 5,5 cm H: 3,3 cm</p> <p>■ zwart Art. nr. 1002660 □ wit Art. nr. 1002659</p>
	<p>Voeding, DALI, aarde binnen 16A max. Polycarbonaat (PC) L: 11,9 cm B: 11,9 cm H: 3,3 cm</p> <p>■ zwart Art. nr. 1002648 □ wit Art. nr. 1002650</p>		<p>Mech. 3-fase-adapter Aluminium / polycarbonaat (PC) L: 6,6 cm B: 6,6 cm H: 3,1 cm</p> <p>■ zwart Art. nr. 175210 □ wit Art. nr. 1001395</p>
	<p>T-verbinder, DALI, aarde buiten, links* 16A max. Polycarbonaat (PC) L: 20,3 cm B: 11,9 cm H: 3,3 cm</p> <p>■ zwart Art. nr. 1002652 □ wit Art. nr. 1002654</p>		<p>Afdekking Polycarbonaat (PC) L: 200 cm B: 2,2 cm H: 0,75 cm</p> <p>■ zwart Art. nr. 1004939 □ wit Art. nr. 1004940</p>
	<p>T-verbinder, DALI, aarde buiten, rechts* 16A max. Polycarbonaat (PC) L: 20,3 cm B: 11,9 cm H: 3,3 cm</p> <p>■ zwart Art. nr. 1002651 □ wit Art. nr. 1002653</p>		<p>Eindkap Polycarbonaat (PC) L: 3,5 cm B: 3,3 cm H: 3,2 cm</p> <p>■ zwart Art. nr. 175060 □ wit Art. nr. 1001380</p>
	<p>T-verbinder, DALI, aarde binnen, links* 16A max. Polycarbonaat (PC) L: 20,3 cm B: 11,9 cm H: 3,3 cm</p> <p>■ zwart Art. nr. 1004941 □ wit Art. nr. 1004942</p>		<p>Pendelophanging Aluminium / polycarbonaat (PC) L: 6 cm B: 6 cm H: 4 cm max. 10 kg</p> <p>■ zwart Art. nr. 175160 □ wit Art. nr. 1001390</p>
	<p>T-verbinder, DALI, aarde binnen, rechts* 16A max. Polycarbonaat (PC) L: 20,3 cm B: 11,9 cm H: 3,3 cm</p> <p>■ zwart Art. nr. 1004943 □ wit Art. nr. 1004944</p>		<p>Stootnaadverbinder Aluminium L: 18,2 cm B: 3,3 cm H: 2,1 cm</p> <p>■ zwart Art. nr. 175180 □ wit Art. nr. 1001392</p>
	<p>X-verbinder, DALI* 16A max. Polycarbonaat (PC) L: 20,3 cm B: 20,3 cm H: 3,3 cm</p> <p>■ zwart Art. nr. 1002655 □ wit Art. nr. 1002656</p>		<p>Haak Polycarbonaat (PC) / staal H: 5,2 cm Ø: 2,6 cm max. 10 kg</p> <p>■ zwart Art. nr. 175190 □ wit Art. nr. 1001393</p>
	<p>Langsverbinder, DALI 16A max. Polycarbonaat (PC) L: 10,6 cm B: 2,5 cm H: 2,8 cm</p> <p>■ zwart Art. nr. 1002641 □ wit Art. nr. 1002642</p>		<p>Plafondrozet 16A max. Polycarbonaat (PC) H: 3,56 cm Ø: 14,32 cm</p> <p>■ sczwart Art. nr. 1004684 □ wewit Art. nr. 1004685</p>
	<p>Langsverbinder, DALI* 10A max. polycarbonaat (PC) L: 20,3 cm B: 3,5 cm H: 3,3 cm</p> <p>■ zwart Art. nr. 1002643 □ wit Art. nr. 1002644</p>		<p>Stalkabelophanging 2 stuks Roestvrij staal / messing L: 500 cm max. 10 kg</p> <p>■ nikkel Art. nr. 1002845</p>
	<p>Flexibele verbinder, DALI 16A max. Polycarbonaat (PC) L: 28,5 cm B: 3,5 cm H: 3,3 cm</p> <p>■ zwart Art. nr. 1002645 □ wit Art. nr. 1002646</p>		

* met voedingsmogelijkheid



Verkrijgbaar met diverse lichtstromen,
kleurtemperaturen en stralingshoeken

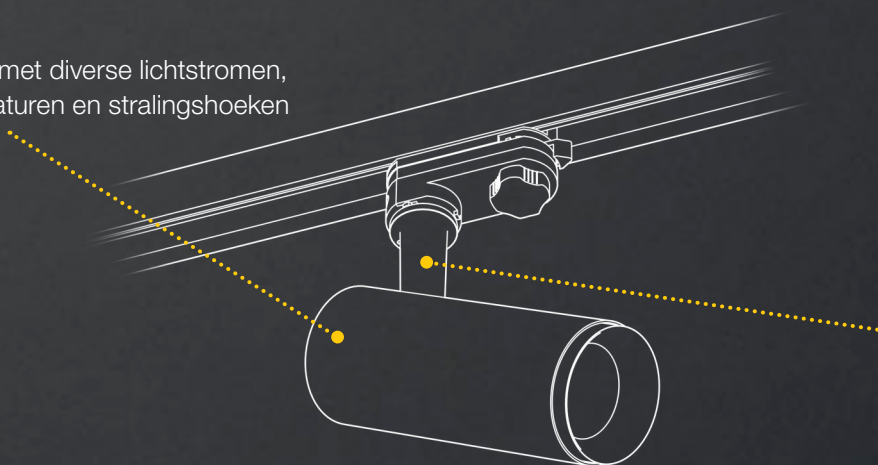

90° zwenkbaar en
350° draaibaar



Naar de SLV NUMINOS® online-configurator:
www.ks-licht.nl/numinos-configurators-nl

NUMINOS® S

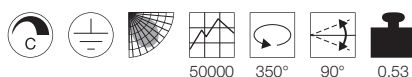

50000 350° 90° 0,53

Nominale spanning (V)	220-240 V ~ 50/60 Hz 250 mA
Systeemvermogen (in W)	11
CRI	90
Materiaal	Aluminium / kunststof
L / Ø / H (cm)	16,2 / 6,5 / 14,5



■ zwart

Kleurtemperatuur (in K)	2700K	2700K	2700K	3000K	3000K	3000K	4000K	4000K	4000K
Lichtstroom (in lm)	985lm	985lm	980lm	1020lm	1020lm	1020lm	1100lm	1100lm	1100lm
Hoek	24°	36°	60°	24°	36°	60°	24°	36°	60°
Art. nr.	1004074	1004075	1004076	1004082	1004083	1004084	1004090	1004091	1004092

□ wit

Kleurtemperatuur (in K)	2700K	2700K	2700K	3000K	3000K	3000K	4000K	4000K	4000K
Lichtstroom (in lm)	985lm	985lm	980lm	1020lm	1020lm	1020lm	1100lm	1100lm	1100lm
Hoek	24°	36°	60°	24°	36°	60°	24°	36°	60°
Art. nr.	1004078	1004079	1004080	1004086	1004087	1004088	1004094	1004095	1004096



Ideale prestatieklasse voor middelgrote winkels en kantoren

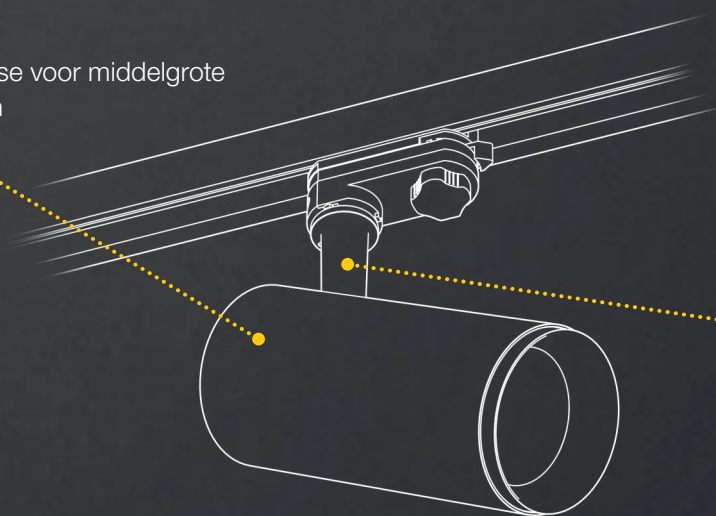

90° zwenkbaar en
350° draaibaar



Naar de SLV NUMINOS® online-configurator:
www.ks-licht.nl/numinos-configurators-nl

NUMINOS® M



50000 350° 90° 0,72

Nominale spanning (V)	220-240V ~50/60Hz 500mA
Systeemvermogen (in W)	20
CRI	90
Materiaal	Aluminium / kunststof
L / Ø / H (cm)	18,5 / 8,5 / 16,5



■ zwart

Kleurtemperatuur (in K)	2700K	2700K	2700K	3000K	3000K	3000K	4000K	4000K	4000K
Lichtstroom (in lm)	1925lm	1935lm	1885lm	1955lm	1970lm	1880lm	2125lm	2120lm	2060lm
Hoek	24°	36°	60°	24°	36°	60°	24°	36°	60°
Art. nr.	1004170	1004171	1004172	1004178	1004179	1004180	1004186	1004187	1004188

□ wit

Kleurtemperatuur (in K)	2700K	2700K	2700K	3000K	3000K	3000K	4000K	4000K	4000K
Lichtstroom (in lm)	1925lm	1935lm	1885lm	1955lm	1970lm	1880lm	2125lm	2120lm	2060lm
Hoek	24°	36°	60°	24°	36°	60°	24°	36°	60°
Art. nr.	1004174	1004175	1004176	1004182	1004183	1004184	1004190	1004191	1004192



Hoogste prestatieklasse voor grote win-
kels en ruimtes

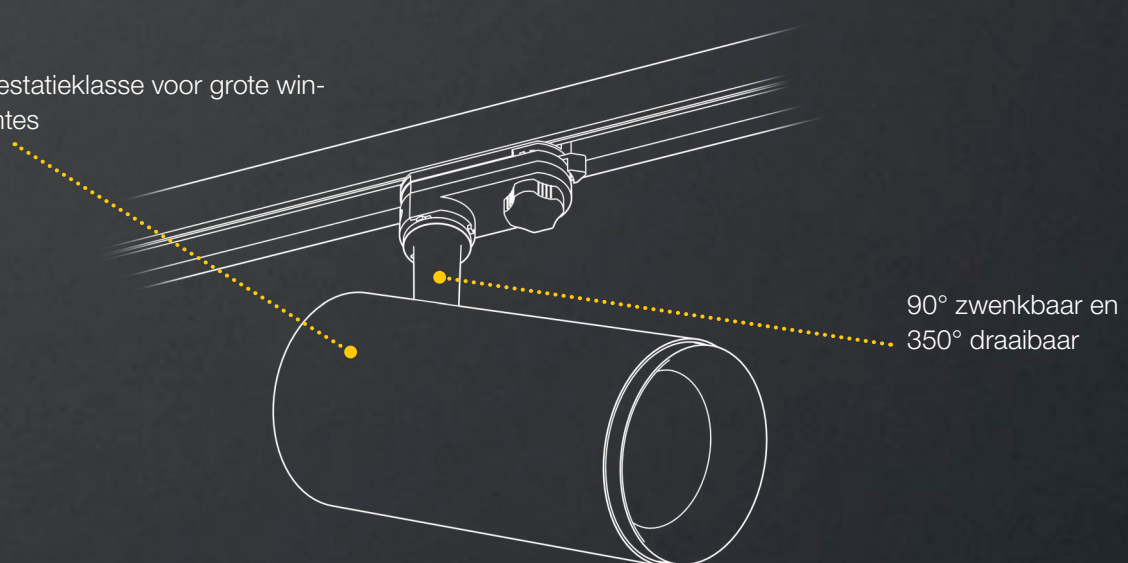

90° zwenkbaar en
350° draaibaar



Naar de SLV NUMINOS® online-configurator:
www.ks-licht.nl/numinos-configurators-nl

NUMINOS® L



NUMINOS® L



Nominale spanning (V)	220-240 V ~ 50/60 Hz 700 mA
Systeemvermogen (in W)	28
CRI	90
Materiaal	Aluminium / kunststof
L / Ø / H (cm)	21,3 / 10 / 18



■ zwart

Kleurtemperatuur (in K)	2700K	2700K	2700K	3000K	3000K	3000K	4000K	4000K	4000K
Lichtstroom (in lm)	2440lm	2400lm	2475lm	2430lm	2340lm	2400lm	2675lm	2620lm	2715lm
Hoek	24°	36°	60°	24°	36°	60°	24°	36°	60°
Art. nr.	1004266	1004267	1004268	1004274	1004275	1004276	1004282	1004283	1004284

□ wit

Kleurtemperatuur (in K)	2700K	2700K	2700K	3000K	3000K	3000K	4000K	4000K	4000K
Lichtstroom (in lm)	2440lm	2400lm	2475lm	2430lm	2340lm	2400lm	2675lm	2620lm	2715lm
Hoek	24°	36°	60°	24°	36°	60°	24°	36°	60°
Art. nr.	1004270	1004271	1004272	1004278	1004279	1004280	1004286	1004287	1004288



Kleinste prestatieklasse voor
DALI-gestuurd licht

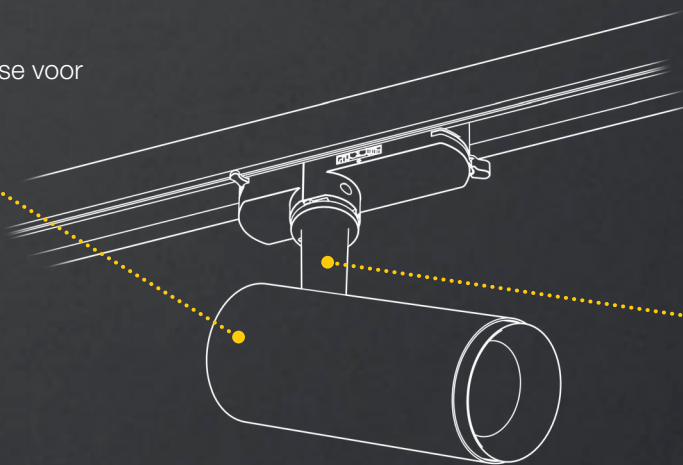

90° zwenkbaar en
350° draaibaar



Naar de SLV NUMINOS® online-configurator:
www.ks-licht.nl/numinos-configurators-nl

NUMINOS® S

DALI

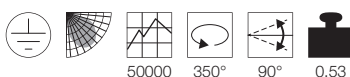

Nominale spanning (V)	220-240 V ~ 50/60 Hz 250 mA
Systeemvermogen (in W)	11
CRI	90
Materiaal	Aluminium / kunststof
L / Ø / H (cm)	16,2 / 6,5 / 14,5



■ zwart

Kleurtemperatuur (in K)	2700K	2700K	2700K	3000K	3000K	3000K	4000K	4000K	4000K
Lichtstroom (in lm)	985lm	985lm	980lm	1020lm	1020lm	1020lm	1100lm	1100lm	1100lm
Hoek	24°	36°	60°	24°	36°	60°	24°	36°	60°
Art. nr.	1004362	1004363	1004364	1004370	1004371	1004372	1004378	1004379	1004380

□ wit

Kleurtemperatuur (in K)	2700K	2700K	2700K	3000K	3000K	3000K	4000K	4000K	4000K
Lichtstroom (in lm)	985lm	985lm	980lm	1020lm	1020lm	1020lm	1100lm	1100lm	1100lm
Hoek	24°	36°	60°	24°	36°	60°	24°	36°	60°
Art. nr.	1004366	1004367	1004368	1004374	1004375	1004376	1004382	1004383	1004384



Middelgrote prestatieklasse voor
DALI-gestuurd licht

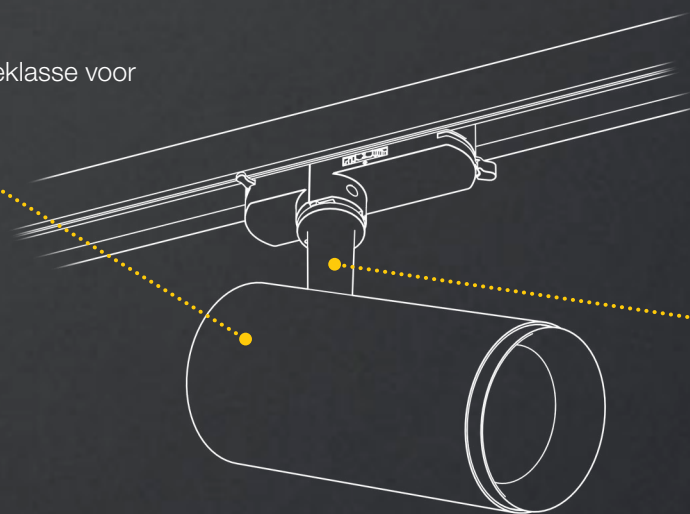

90° zwenkbaar en
350° draaibaar



Naar de SLV NUMINOS® online-configurator:
www.ks-licht.nl/numinos-configurators-nl

NUMINOS® M

DALI

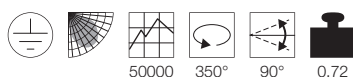

50000 350° 90° 0,72

Nominale spanning (V)	220-240V ~50/60Hz 500mA
Systeemvermogen (in W)	20
CRI	90
Materiaal	Aluminium / kunststof
L / Ø / H (cm)	18,5 / 8,5 / 16,5



■ zwart

Kleurtemperatuur (in K)	2700K	2700K	2700K	3000K	3000K	3000K	4000K	4000K	4000K
Lichtstroom (in lm)	1925lm	1935lm	1885lm	1955lm	1970lm	1880lm	2125lm	2120lm	2060lm
Hoek	24°	36°	60°	24°	36°	60°	24°	36°	60°
Art. nr.	1004458	1004459	1004460	1004466	1004467	1004468	1004474	1004475	1004476

□ wit

Kleurtemperatuur (in K)	2700K	2700K	2700K	3000K	3000K	3000K	4000K	4000K	4000K
Lichtstroom (in lm)	1925lm	1935lm	1885lm	1955lm	1970lm	1880lm	2125lm	2120lm	2060lm
Hoek	24°	36°	60°	24°	36°	60°	24°	36°	60°
Art. nr.	1004462	1004463	1004464	1004470	1004471	1004472	1004478	1004479	1004480



Hoogste prestatieklasse voor
DALI-gestuurd licht

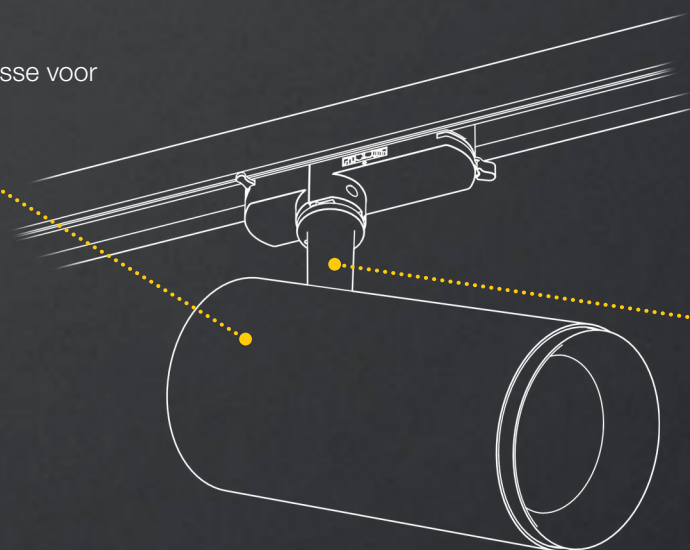

90° zwenkbaar en
350° draaibaar



Naar de SLV NUMINOS® online-configurator:
www.ks-licht.nl/numinos-configurators-nl

NUMINOS® L

DALI

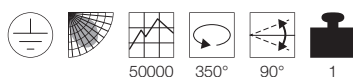

Nominale spanning (V)	220-240 V ~ 50/60 Hz 700 mA
Systeemvermogen (in W)	28
CRI	90
Materiaal	Aluminium / kunststof
L / Ø / H (cm)	21,3 / 10 / 18



■ zwart

Kleurtemperatuur (in K)	2700K	2700K	2700K	3000K	3000K	3000K	4000K	4000K	4000K
Lichtstroom (in lm)	2440lm	2400lm	2475lm	2430lm	2340lm	2400lm	2675lm	2620lm	2715lm
Hoek	24°	36°	60°	24°	36°	60°	24°	36°	60°
Art. nr.	1004554	1004555	1004556	1004562	1004563	1004564	1004570	1004571	1004572

□ wit

Kleurtemperatuur (in K)	2700K	2700K	2700K	3000K	3000K	3000K	4000K	4000K	4000K
Lichtstroom (in lm)	2440lm	2400lm	2475lm	2430lm	2340lm	2400lm	2675lm	2620lm	2715lm
Hoek	24°	36°	60°	24°	36°	60°	24°	36°	60°
Art. nr.	1004558	1004559	1004560	1004566	1004567	1004568	1004574	1004575	1004576



Ideaal als basisverlichting in kantoren en winkels

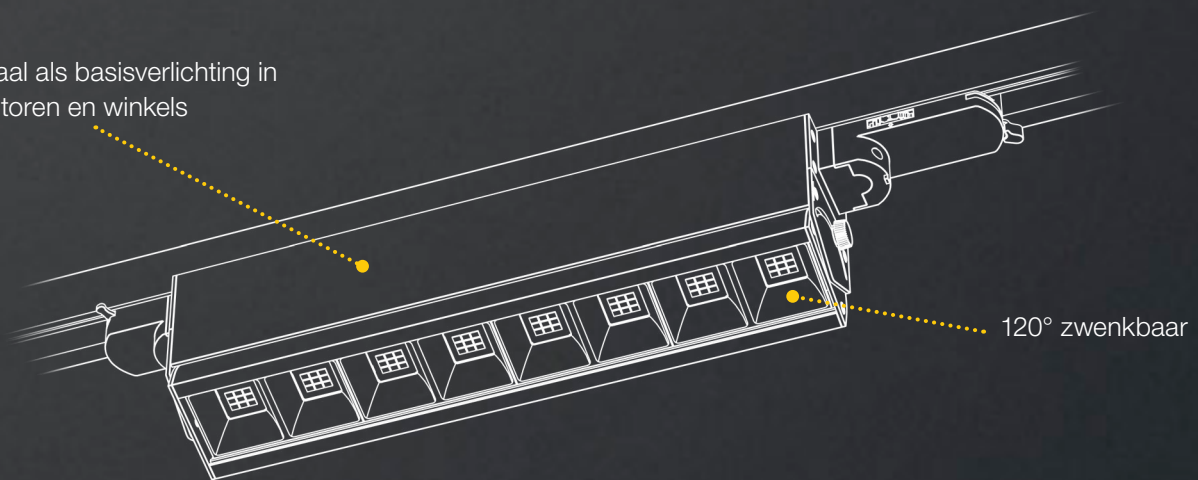

SIGHT MOVE

DALI



Nominale spanning (V)	220 - 240 V ~ 50/60 Hz 350 mA			
Systeemvermogen (in W)	26			
CRI	90			
Materiaal	Aluminium / polymethylmethacrylaat (PMMA)			
L / B / H (cm)	45 / 5,6 / 10,5			



	■ zwart		□ wit	
Kleurtemperatuur (in K)	3000K	4000K	3000K	4000K
Lichtstroom (in lm)	2700lm	3100lm	2700lm	3100lm
Art. nr.	1004690	1004692	1004691	1004693

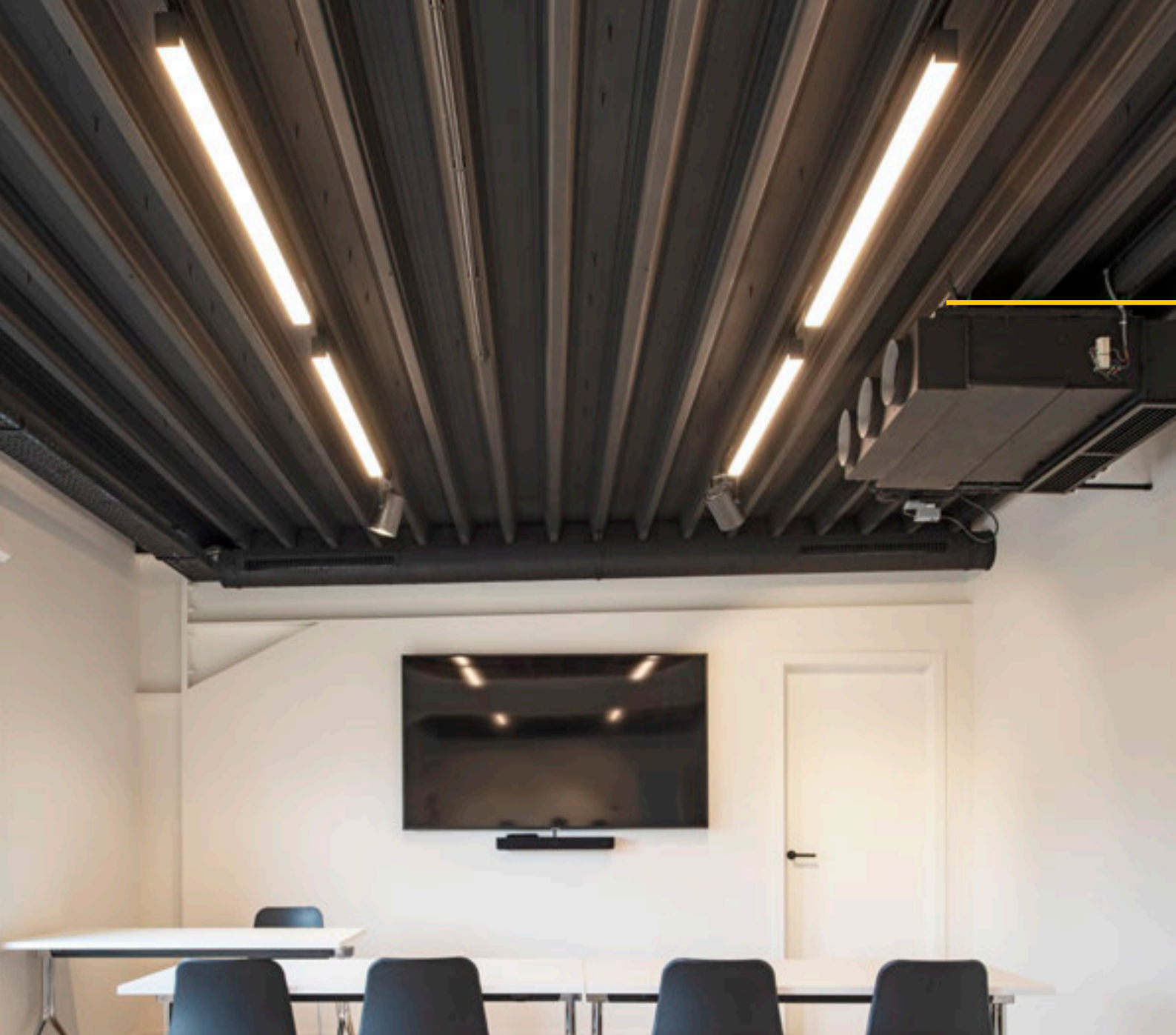

Ideaal als basisverlichting
in kantoren en winkels



Keuze kleur-
temperatuur (CCT)



SIGHT TRACK

DALI

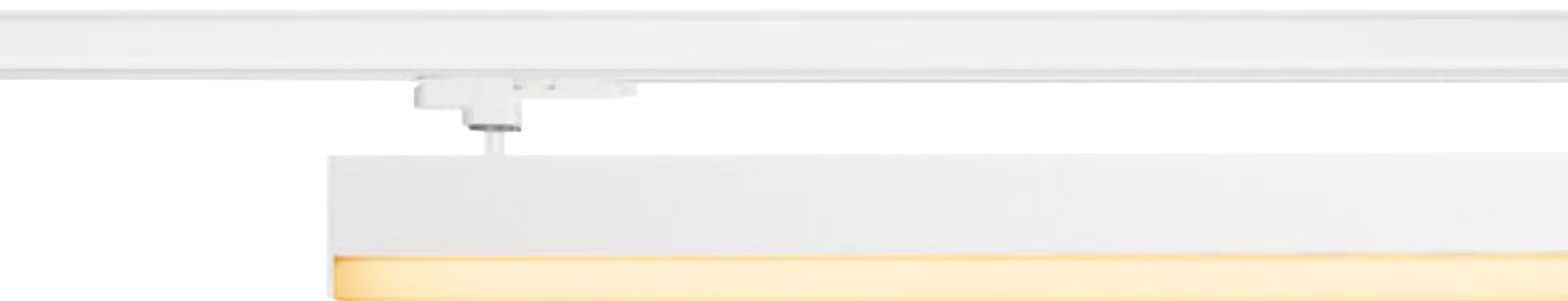

SIGHT TRACK DALI



Nominale spanning (V)	220-240 V ~ 50/60 Hz 700 mA	
Systeemvermogen (in W)	39	
CRI	90	
Materiaal	Aluminium/acryl	
L / B / H (cm)	114 / 4,5 / 12	

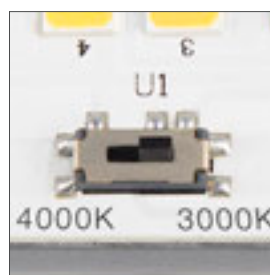

	<input checked="" type="checkbox"/> zwart	<input type="checkbox"/> wit
Kleurtemperatuur (in K)	3000K/4000K	3000K/4000K
Lichtstroom (in lm)	3000lm/3000lm	3000lm/3000lm
Art. nr.	1005397	1005399



Geeft indirect licht

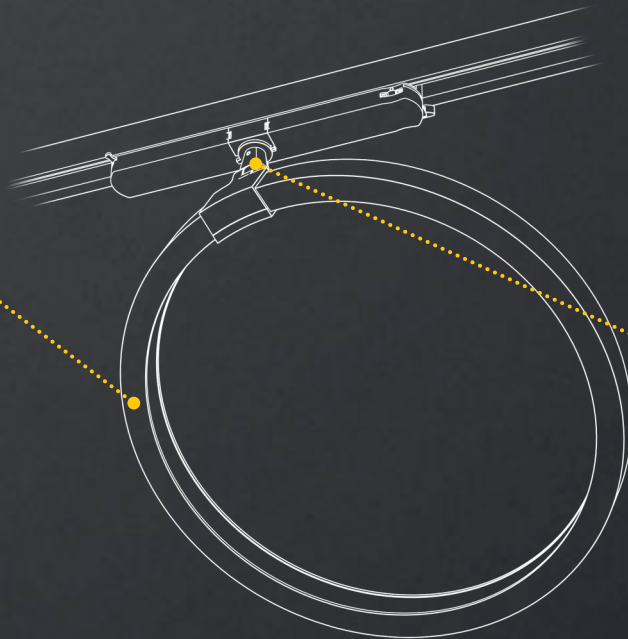

100° zwenkbaar en
350° draaibaar



ONE 40 TRACK

DALI

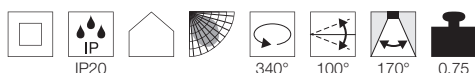

Nominale spanning (V)	220 - 240 V ~ 50/60 Hz 350 mA			
Systeemvermogen (in W)	15,2			
CRI	90			
Materiaal	Aluminium			
Ø / H (cm)	40 / 10,5			



	■ zwart		□ wit	
Kleurtemperatuur (in K)	3000K	4000K	3000K	4000K
Lichtstroom (in lm)	650lm	670lm	650lm	670lm
Art. nr.	1004769	1004771	1004770	1004772



3-fase-opbouwrail

Standaard oplossing nodig?

U op zoek bent naar een railsysteem dat zichzelf in de verlichtingswereld bewezen heeft. Of de aanbesteding / voorschrijver vraagt er specifiek om: de aluminium draagrail van EUTRAC®. Het driefasige hoogspanningsrailsysteem is compatibel met de armaturen van SLV. De opbouwversie is in meerdere kleuren en lengtes verkrijgbaar.

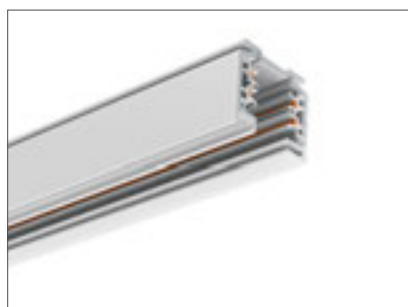

	1 m	1 m	1 m	2 m	2 m	2 m
Nominale spanning (V)	220-240V ~50/60Hz	220-240V ~50/60Hz	220-240V ~50/60Hz	220-240V ~50/60Hz	220-240V ~50/60Hz	220-240V ~50/60Hz
Max. stroomsterkte (A)	16	16	16	16	16	16
Materiaal	Aluminium / polycarbonaat (PC)	Aluminium / polycarbonaat (PC)	Aluminium / polycarbonaat (PC)	Aluminium / polycarbonaat (PC)	Aluminium / polycarbonaat (PC)	Aluminium / polycarbonaat (PC)
Kleur	■ zwart	□ wit	■ grijs	■ zwart	□ wit	■ grijs
L x B x H (cm)	100 x 3,6 x 3,2	100 x 3,6 x 3,2	100 x 3,6 x 3,2	200 x 3,6 x 3,2	200 x 3,6 x 3,2	200 x 3,6 x 3,2
Gewicht (kg)	1,0	1,0	1,0	2,0	2,0	2,0
Art. nr.	145100	1001510	145102	145200	1001511	145202

Fabrikant: EUTRAC® Stromschienen GmbH

	3 m	3 m	3 m
Nominale spanning (V)	220-240V ~50/60Hz	220-240V ~50/60Hz	220-240V ~50/60Hz
Max. stroomsterkte (A)	16	16	16
Materiaal	Aluminium / polycarbonaat (PC)	Aluminium / polycarbonaat (PC)	Aluminium / polycarbonaat (PC)
Kleur	■ zwart	□ wit	■ grijs
L x B x H (cm)	300 x 3,6 x 3,2	300 x 3,6 x 3,2	300 x 3,6 x 3,2
Gewicht (kg)	3,0	3,0	3,0
Art. nr.	145300	1001512	145302

Fabrikant: EUTRAC® Stromschienen GmbH

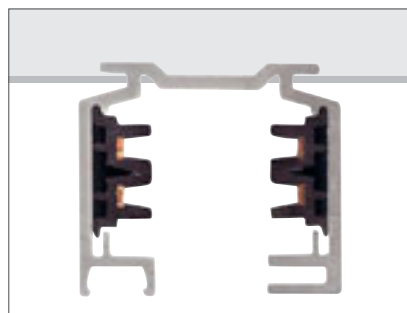

EUTRAC®

3-fase-opbouwrail Planningshulp en toebehoren in één overzicht

Zicht op de componenten van
bovenaf op de montagezijde

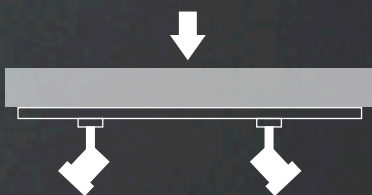

145510
1001513
145514



145520
1001514
145524



145670
1001520
145674



145680
1001521
145684



145630
1001518
145634

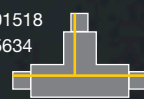

145640
1001519
145644

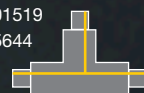

145690
1001522
145694



Voorbeeld: aarde buiten

145670
1001520
145674

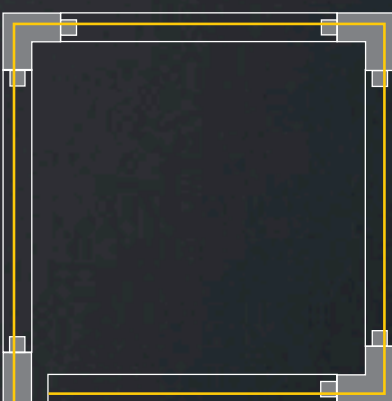

145670
1001520
145674

145680
1001521
145684

145520
1001514
145524



Voorbeeld: aarde
binnen

145510
1001513
145514

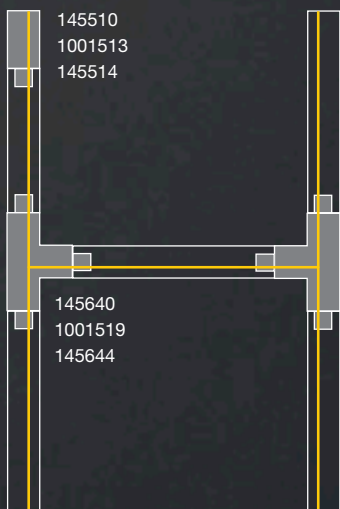

145630
1001518
145634

145680
1001521
145684

145690
1001522
145694

145680
1001521
145684

145520
1001514
145524

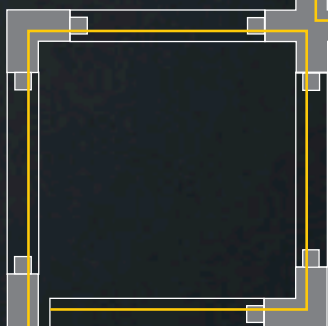

145680
1001521
145684

**Voeding, aarde links**

16A max. | Polycarbonaat (PC)
L: 11,2 cm B: 3,6 cm H: 3,2 cm

- zwart Art. nr. 145510
- wit Art. nr. 1001513
- grijs Art. nr. 145514

**Stootnaadverbinder**

Polycarbonaat (PC)
L: 10 cm B: 3,6 cm H: 1,9 cm

- zwart Art. nr. 145600
- wit Art. nr. 1001523
- grijs Art. nr. 145604

**Voeding, aarde rechts**

16A max. | Polycarbonaat (PC)
L: 11,2 cm B: 3,6 cm H: 3,2 cm

- zwart Art. nr. 145520
- wit Art. nr. 1001514
- grijs Art. nr. 145524

**Flexverbinder**

16A max. | Polycarbonaat (PC) / staal
L: 22 cm B: 3,6 cm H: 3,2 cm

- zwart Art. nr. 145580
- wit Art. nr. 1001524
- grijs Art. nr. 145584

**Middenvoeding**

16A max. | Polycarbonaat (PC)
L: 13 cm B: 3,6 cm H: 3,6 cm

- zwart Art. nr. 145530
- wit Art. nr. 1001515
- grijs Art. nr. 145534

**Contactdoos**

10A max. | polycarbonaat (PC)
L: 9,6 cm B: 6,5 cm H: 9 cm

- zwart Art. nr. 145700
- wit Art. nr. 1001525

**Langsverbinder***

16A max. | Polycarbonaat (PC) / staal
L: 26 cm B: 3,6 cm H: 3,2 cm

- zwart Art. nr. 145660
- wit Art. nr. 1001517
- grijs Art. nr. 145664

**3-fase armatuuradapter**

10A max. | polycarbonaat (PC)

- zwart Art. nr. 145990
- wit Art. nr. 1001542
- grijs Art. nr. 145994

**Langsverbinder**

16A max. | Polycarbonaat (PC)
L: 5,8 cm B: 1,5 cm H: 2,6 cm

- zwart Art. nr. 145560
- wit Art. nr. 1001516
- grijs Art. nr. 145564

**Pendelclip**

Aluminium
L: 5 cm B: 3,6 cm H: 1,9 cm

- zwart Art. nr. 145730
- wit Art. nr. 1001530
- grijs Art. nr. 145734

**L-verbinder, aarde binnen***

16A max. | Polycarbonaat (PC) / staal
L: 15 cm B: 15 cm H: 3,2 cm

- zwart Art. nr. 145680
- wit Art. nr. 1001521
- grijs Art. nr. 145684

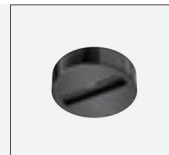
**Universele rozet**

16A max. | Polycarbonaat (PC)
H: 3,1 cm Ø: 11,9 cm

- zwart Art. nr. 145830
- wit Art. nr. 1001526
- grijs Art. nr. 145834

**L-verbinder, aarde buiten***

16A max. | Polycarbonaat (PC) / staal
L: 15 cm B: 15 cm H: 3,2 cm

- zwart Art. nr. 145670
- wit Art. nr. 1001520
- grijs Art. nr. 145674

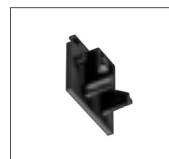
**Eindkap**

Polycarbonaat (PC)
L: 3,6 cm B: 1,7 cm H: 3,2 cm

- zwart Art. nr. 145590
- wit Art. nr. 1001527
- grijs Art. nr. 145594

**T-verbinder, aarde binnen, links***

16A max. | Polycarbonaat (PC) / staal
L: 26 cm B: 18,5 cm H: 3,2 cm

- zwart Art. nr. 145630
- wit Art. nr. 1001518
- grijs Art. nr. 145634

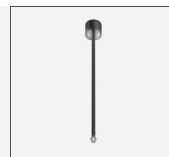
**Pendelophanging**

Polycarbonaat (PC) / staal
L: 60 cm H: 63,5 cm Ø: 7 cm

- zwart Art. nr. 145720
- wit Art. nr. 1001529
- grijs Art. nr. 145724

**T-verbinder, aarde binnen, rechts***

16A max. | Polycarbonaat (PC) / staal
L: 26 cm B: 18,5 cm H: 3,2 cm

- zwart Art. nr. 145640
- wit Art. nr. 1001519
- grijs Art. nr. 145644

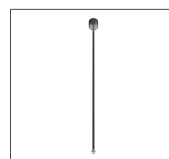
**Pendelophanging**

Polycarbonaat (PC) / staal
L: 120 cm H: 122 cm Ø: 7 cm

- zwart Art. nr. 145710
- wit Art. nr. 1001528
- grijs Art. nr. 145714

**X-Verbinder***

16A max. | Polycarbonaat (PC) / staal
L: 26 cm B: 26 cm H: 3,2 cm
2 gescheiden stroomkringen

- zwart Art. nr. 145690
- wit Art. nr. 1001522
- grijs Art. nr. 145694

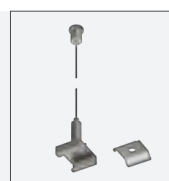
**Staalkabelophanging 2 stuks**

Roestvrij staal / messing
L: 500 cm | max. 10 kg

- nikkel Art. nr. 1002845

* met voedingsmogelijkheid



3-fase inbouwrail met passend toebehoren

Voor visueel bijzonder veeleisende projecten:
de inbouwversie van de EUTRAC® Hoogvoltage 3-fase rail

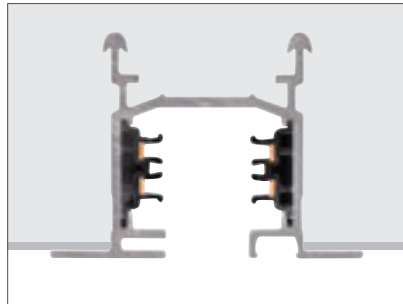

	2 m	3 m
Nominale spanning (V)	220-240V ~50/60Hz	220-240V ~50/60Hz
Max. stroomsterkte (A)	16	16
Materiaal	Aluminium / polycarbonaat (PC)	Aluminium / polycarbonaat (PC)
Kleur	<input type="checkbox"/> wit	<input type="checkbox"/> wit
L x B x H (cm)	200 x 5,9 x 4,1	300 x 5,9 x 4,1
Inbouw-B (cm)	4	4
Gewicht (kg)	2,6	3,9
Art. nr.	1001531	1001532

Fabrikant: EUTRAC® Stromschienen GmbH



Voeding, aarde links

16A max. | Polycarbonaat (PC) / staal
L: 12,2 cm B: 6 cm H: 3,4 cm

wit

Art. nr. 1001533

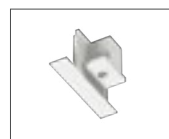

Eindkap

Polycarbonaat (PC)
L: 2,7 cm B: 6 cm H: 3,2 cm

wit

Art. nr. 1001538



Voeding, aarde rechts

16A max. | Polycarbonaat (PC) / staal
L: 12,2 cm B: 6 cm H: 3,4 cm

wit

Art. nr. 1001534



Langsverbinder met stabilisator

16A max. | Polycarbonaat (PC) / staal
L: 6,2 cm B: 2,5 cm H: 2,7 cm

wit

Art. nr. 1001539

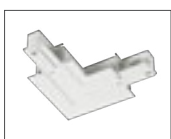

Inbouw L-verbinder met voeding

16A max. | Polycarbonaat (PC) / staal
L: 16 cm B: 16 cm H: 3,2 cm
Aarde buiten, met voedingsmogelijkheid

wit

Art. nr. 1001536

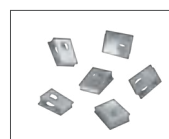

Veerclip

Staal
L: 2 cm B: 1 cm H: 2,5 cm

grijs

Art. nr. 145551

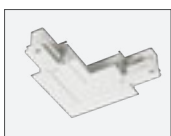

Inbouw L-verbinder met voeding

16A max. | Polycarbonaat (PC) / staal
L: 16 cm B: 16 cm H: 3,2 cm
Aarde binnen, met voedingsmogelijkheid

wit

Art. nr. 1001537



3-fase armatuuradapter

10A max. | polycarbonaat (PC)

wit

Art. nr. 1001542

COMPATIBILITEIT

3-fase stroomrails

Compatibel met armaturen/adapters van:

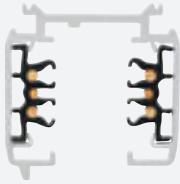
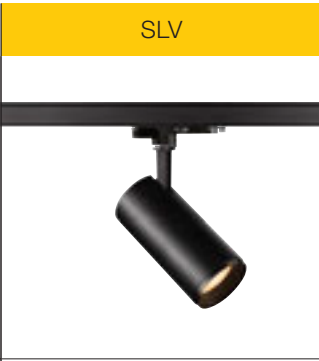
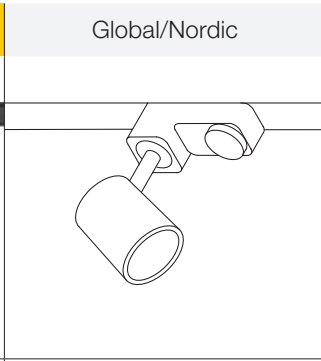
 Rails en railcomponenten S-Track DALI	Gebruik	SLV	Global/Nordic
			
zonder DALI		✓	✓
met DALI		✓	✓

Compatibel met rails en railcomponenten van:

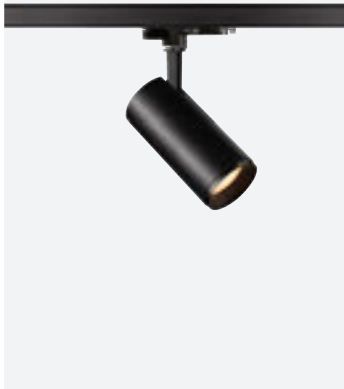
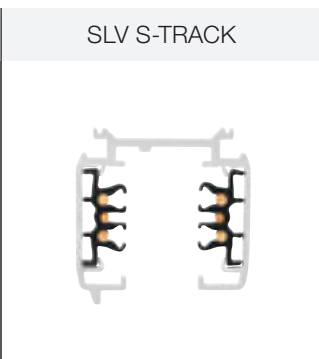
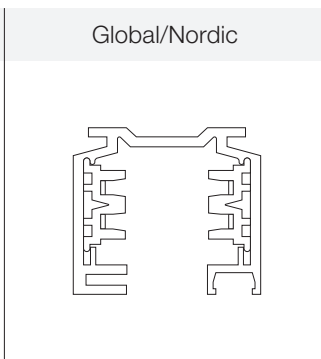
 Armaturen S-Track DALI	Gebruik	SLV S-TRACK	Global/Nordic
			
zonder DALI		✓	✓
met DALI		✓	✓

★ Onder voorbehoud van voorafgaande controle aan de hand van modellen van de armaturen en rails

★★ Maar zonder DALI-functionaliteit

Gegevens onder voorbehoud van wijziging.

Technische gegevens en afmetingen kunnen te allen tijde zonder voorafgaande kennisgeving worden gewijzigd.

Controleer de functionering al tijdens de planning van het project aan de hand van demo's.

De compatibiliteit heeft uitsluitend betrekking op rails en armaturen.

Rails en railcomponenten van verschillende fabrikanten mogen niet met elkaar worden gecombineerd.

De SLV-railsystemen en -componenten zijn zeer compatibel.
 Met armaturen en adapters van EUTRAC®, Zumtobel, Erc en
 LTS ONETrack. Onder voorbehoud van de voorafgaande test
 met demo's van de armaturen en rails.

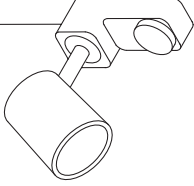
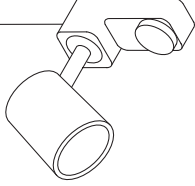
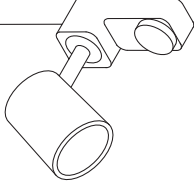
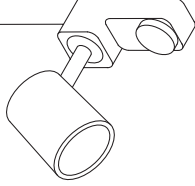
	EUTRAC®	Zumtobel	Erc	LTS ONETrack
				
	★	✓	✓	✓
	✗	✓	✓	✓

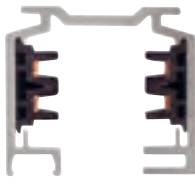
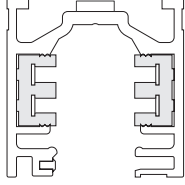
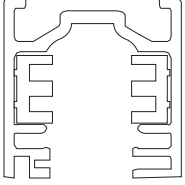
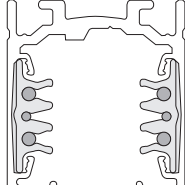
	EUTRAC®	Zumtobel	Erc	LTS ONETrack
				
	✓	✓	✓	✓
	✓★★	✓	✓	✓



Inspiratie opgedaan?

Heeft u op de website van NUMINOS® inspiratie opgedaan en bent u via een toepassingsvoorbeeld bij de configurator uitgekomen? Dan zijn de technische keuzemogelijkheden al optimaal ingesteld.

NUMINOS®

Systematisch online configureren.

In een paar stappen naar de juiste railspot – de SLV NUMINOS® Online-configurator maakt het mogelijk.

NUMINOS® is een perfect op elkaar afgestemd armaturesysteem, dat constante lichteigenschappen en een modern design voor alle toepassingen biedt. Onze online-configurator helpt u te kiezen uit een groot aantal maten en diameters, prestatieklassen, lensvarianten en stralingshoeken de perfecte spotlight voor uw projecten.

Naast de spots voor 3-fase railsystemen zijn de NUMINOS® spotlights ook verkrijgbaar als zwenkbare of vaste plafondspots en pendelarmaturen.



Naar de SLV NUMINOS® online-configurator:
www.ks-licht.nl/numinos-configurators-nl



SPOTLIGHTS

Verkrijgbaar in drie maten behuizingen (65x155 mm, 85x175 mm, 100x203 mm) met high performance led-module in drie lichtkleuren (2700K, 3000K, 4000K).

Door de ingebouwde led-driver (geschikt voor fasedimming, DALI) zijn alle spotlights geschikt voor directe aansluiting op een netspanning van 230V.

Selecteerbare lenzen met stralingshoeken van 24°, 36° of 60°.

NUMINOS® Spotlights zijn verkrijgbaar als zwenkbare of vaste plafondspot, pendelarmatuur en als spot voor 3-fasen railsystemen.



Heeft u nog vragen?

Scan de QR-code voor een video die duidelijk laat zien hoe gemakkelijk NUMINOS® armaturen kunnen worden geconfigureerd.





SYMBOLVERKLARING



PRODUCTEIGENSCHAPPEN

Informatie over **het feit of lichtbronnen en voorschakelapparatuur** van eindgebruikers of gekwalificeerde personen **zonder blijvende schade aan de armaturen vervangen kunnen worden.**



· LED kan door gekwalificeerde persoon vervangen worden



Gewicht van het product in kilogram (kg)

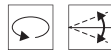

Draai- en zwenkbaarheid in graden:

· Draaibereik
· Zwenkbereik



De stralingshoek

Beschrijft de uitstralingshoek in graden. Hoe kleiner de hoek des te sterker wordt het licht gebundeld.



Gemiddelde levensduur van een armatuur resp. van een lichtbron in uren.



Het lichtstroombehoud

Beschrijft de afname van de hoeveelheid lichtstroom van een led in de vermelde periode.



Op aanvraag sturen wij u graag een lichtverdelingscurve van het betreffende product toe.

VEILIGHEIDSTECHNISCHE GEGEVENS



Beschermingsklassen

· Beschermingsklasse I / aarddraad
· Beschermingsklasse II / beveiliging door dubbele of versterkte isolatie

TOEPASSINGSBEREIK · MONTAGE



IP-beschermingsklasse

Geeft de geschiktheid van elektrische apparaten aan voor verschillende omstandigheden.



Gebruik **uitsluitend** voor binnenruimtes

BIJZONDERE SYMBOLEN



Markeert producten

· met **ingebouwde** led's



Connected Lighting

Omschrijft slimme producten die de onderstaande protocollen gebruiken:

· DALI

Foto's en afbeeldingen

© SLV GmbH, 2021

© Chlorophylle | Adobe Stock



KS Licht- u. Elektrotechnik GmbH
Manderscheidstr. 8c
45141 Essen

Tel.: +49 (0)201-89924-0
Fax: +49 (0)201-89924-124

Internet: www.KS-Germany.com
Email: Verkauf@KS-Germany.com